

# Ideal Network Setup

We know all networks are different, but if you follow the basic structure laid out in the following two examples, you should be in good shape.

Regardless of network complexity, please do observe the following rules:

1. Keep your phone system network isolated from any security camera or streaming audio systems.
2. Do not double NAT. Only one device should be DHCP'ing on your phone system network.
3. Only use UNMANAGED switches. An unmanaged MANAGED switch will NOT work!
4. Do not use MESH routers or range extenders. Only use Access Points.

## Basic Networks

### Basic Network

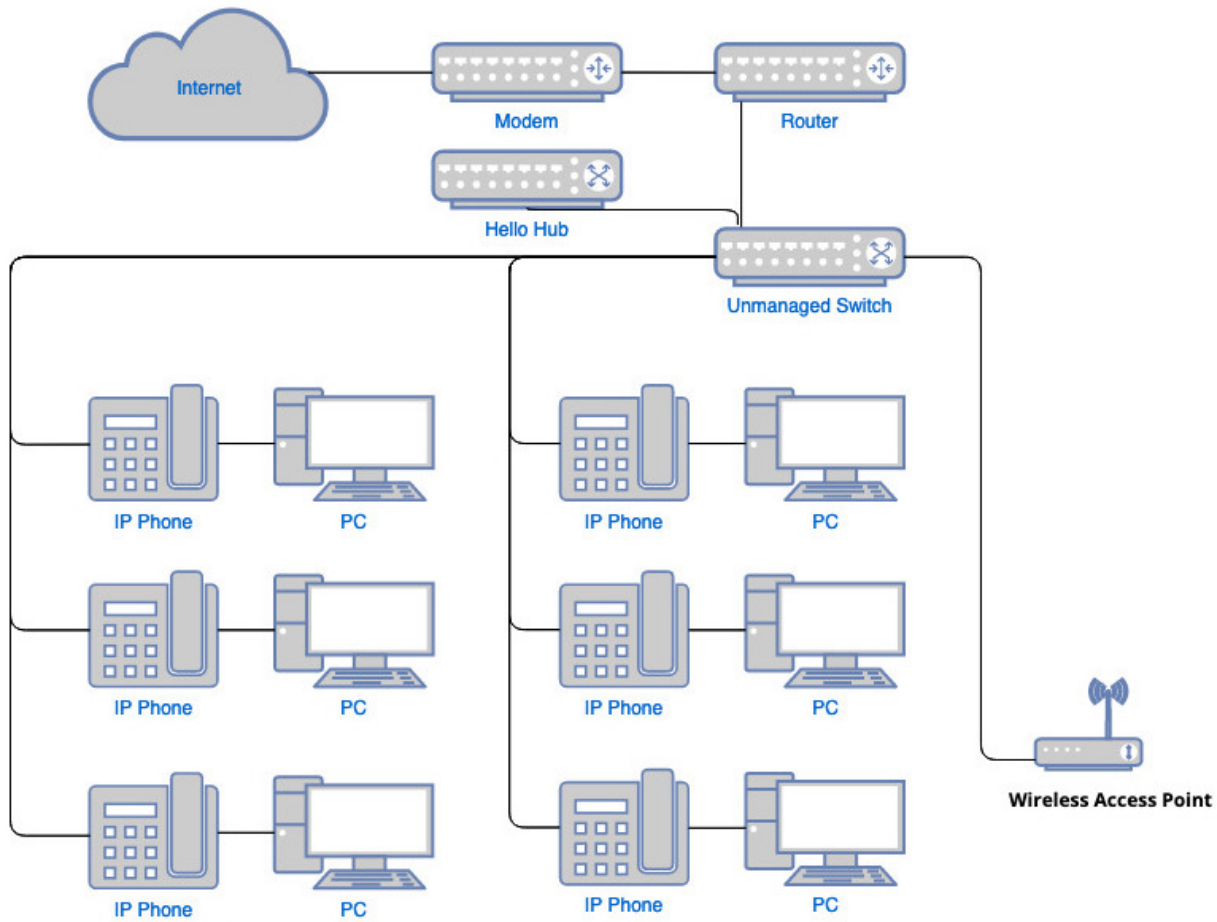

#### General Notes

DO NOT USE MESH ROUTERS!!!  
 DO NOT USE RANGE EXTENDERS!!!  
 Use traditional Access Points, instead.

AVOID MANAGED SWITCHES unless you are excellent at configuring/managing them.

**Unmanaged Switches should be used if at all possible.**

Keep any IP Cameras and Streaming Audio systems on a wholly separate network from your phone system.

#### ====Complex Networks====

For a system requiring security on CPUs, please use separate LAN drops.

Phones should be on a relaxed security VLAN and an unmanaged switch if possible. CPU's may then be on a separate switch/VLAN with whatever security is required.

### Complex Network

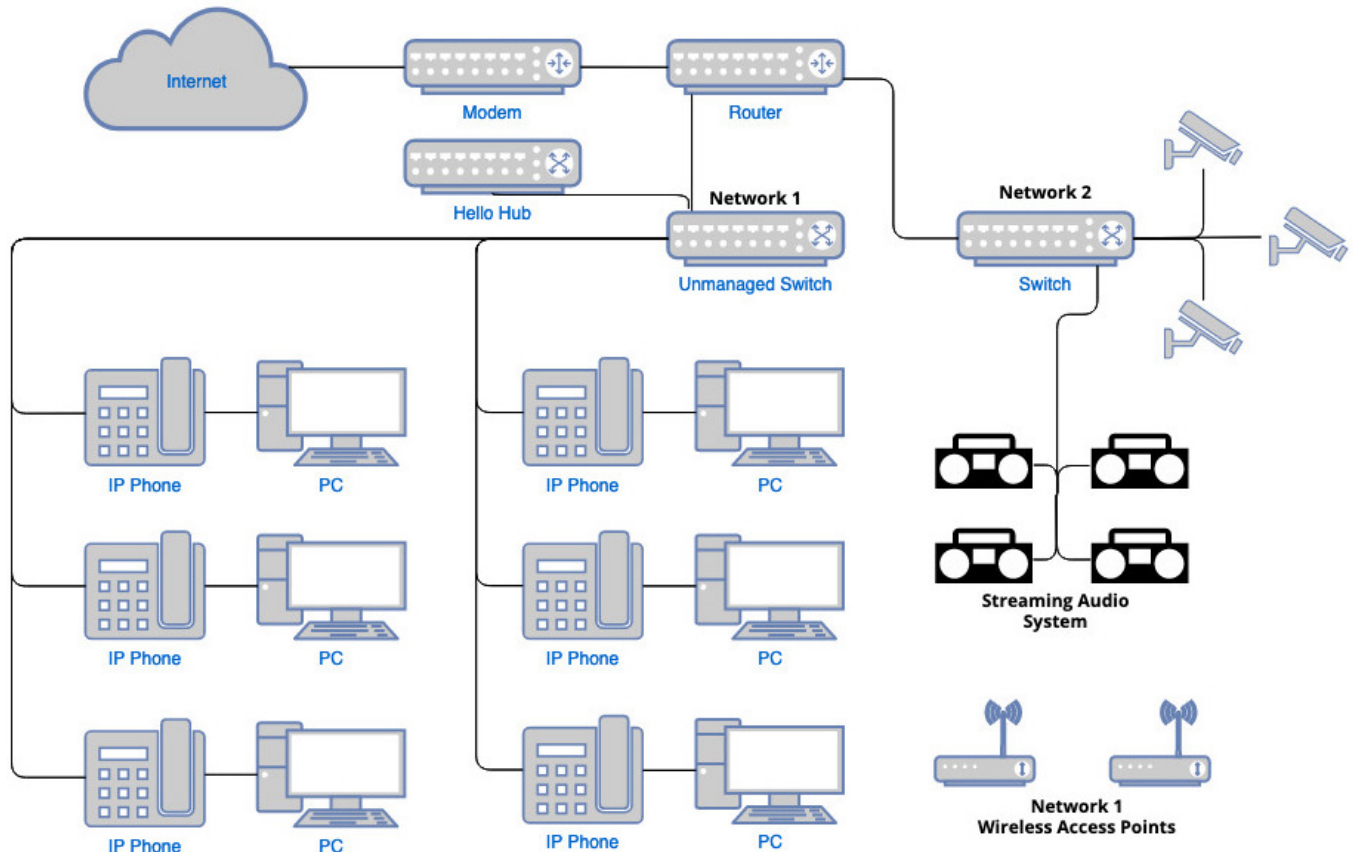

#### General Notes

DO NOT USE MESH ROUTERS!!!  
 DO NOT USE RANGE EXTENDERS!!!  
 Use traditional Access Points, instead.

AVOID MANAGED SWITCHES unless you are excellent at configuring/managing them.  
**Unmanaged Switches should be used if at all possible.**

#### Network 1

Keep any IP Cameras and Streaming Audio systems on a wholly separate network from your phone system.

From: <https://wiki.ring-u.com/wiki/> - support wiki

Permanent link: <https://wiki.ring-u.com/wiki/doku.php?id=ideal-network-setup&rev=1669044716>

Last update: 2025/11/02 18:50

